

### Features:

- ✓ Small size, minimal footprint – SMT/SIP package
- ✓ 16A Output Current (all voltages)
- ✓ High Efficiency: up to 94%
- ✓ High reliability
- ✓ RoHS Compliant
- ✓ Cost efficient open frame design
- ✓ Output voltage programmable by an external resistor.
- ✓ Monotonic Start with Pre-Bias.
- ✓ +ve Enable Logic and –ve Enable Logic models available

Output				Input			Efficiency		
Vout (V)	Iout (A)	PARD (mVp-p)		Regulation Max		Vin Nom. (V)	Range (V)	Iin Typ (A)	Full Load Typ.
		Typ.	Max.	Line	Load				
0.75	16	50	75	+/-0.2%	+/-0.5%	12	8.3 – 14	1.299	77%
1.2	16	50	75	+/-0.2%	+/-0.5%	12	8.3 – 14	1.928	83%
1.5	16	50	75	+/-0.2%	+/-0.5%	12	8.3 – 14	2.326	86%
1.8	16	50	75	+/-0.2%	+/-0.5%	12	8.3 – 14	2.727	88%
2.0	16	50	75	+/-0.2%	+/-0.5%	12	8.3 – 14	2.996	89%
2.5	16	50	75	+/-0.2%	+/-0.5%	12	8.3 – 14	3.704	90%
3.3	16	50	75	+/-0.2%	+/-0.5%	12	8.3 – 14	4.783	92%
5.0	16	50	75	+/-0.2%	+/-0.5%	12	8.3 – 14	7.092	94%



Input Characteristics	Notes & Conditions	Min	Typ.	Max	Units
Input Voltage Operating Range		8.3	12	14	Vdc
Input Reflected Ripple Current			200		mA p-p
Inrush Current Transient				0.2	A <sup>2</sup> s
Input Filter Type (external)			100		μF
Input Turn ON Threshold			8.5		V
Input Turn OFF Threshold			8.0		V
ON Control	Open Circuit or =Vin				
OFF Control	< 0.4Vdc				

Output Characteristics	Notes & Conditions	Min	Typ.	Max	Units
Vout Accuracy	100% load	-1.5		+1.5	%
Output Loading		0		16	A
Output Ripple & Noise @ 20Mhz Bandwidth.				75	MVp-p
Maximum Capacitive Load	Low ESR			8000	μF
Vout Trim Range (Nom)		0.75		5.0	V
Total Accuracy	Over line/load temperature		<2%		
Current Limit			23		A
Output Line Regulation		-0.2		+0.2	%
Output Load Regulation		-0.5		+0.5	%
Turn-on Overshoot				1	%
SC Protection Technique	Hiccup with auto recovery				
Pre-bias Start-up at output	Unit starts monotonically with pre-bias				

Dynamic Characteristics	Notes & Conditions	Min	Typ.	Max	Units
Load Transient	50% step, 0.1A/μs			100	mV
	Settling Time			200	μs
Frequency			300		KHz
Rise Time	10% Vo to 90% Vo		3.5		ms
Start-Up Time	Vin to Vout and On/Off to Vout Vout rise to monotonic		7		ms

General Specifications	Notes & Conditions	Min	Typ.	Max	Units
MTBF	Calculated (MIL-HDBK-217F) Calculated (Bellcore TR-332, Issue 6)		1.0 4.78		x10 <sup>6</sup> Hrs x10 <sup>6</sup> Hrs
Thermal Protection	Hotspot		110		°C
Operating Temperature	Without derating 300LFM	-40		50	°C
Operating Ambient Temperature	See Power derating curve	-40		85	°C
SIP Dimensions	2"Lx0.327"Wx0.512"H (50.8x8.3x13.0mm)				
SMT Dimensions	1.30"Lx0.53"Wx0.366"H (33x13.46x9.3mm)				
SIP Pin Dimensions	0.025" (0.64mm) SQUARE		0.64		mm
SMT Block Dimensions	0.063" x0.065" x 0.112" SQUARE				
Pin and Block Material	Matte Sn Finish on component Leads				
Weight			10		g
Flammability Rating	UL94V-0				

<b>Standards Compliance</b>
CSA C22.2, No.60950/UL 60950, Third Edition (2000), File UL E165113

**Thermal Considerations**

The power module operates in a variety of thermal environments; however, sufficient cooling should be provided to help ensure reliable operation of the unit.

The thermal data presented is based on measurements taken at various airflows. Note that airflow is parallel to the long axis of the module as shown in Figure 1 and derating applies accordingly.

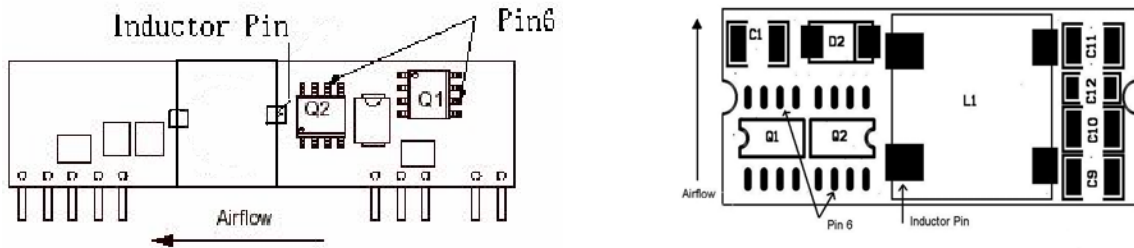

Figure 1. Thermal Tests Set-Up.

The temperature at either location should not exceed 110°C. The output power of the module should not exceed the rated power for the module ( $V_{o,set} \times I_{o,max}$ ).

**Convection Requirements for Cooling**

To predict the approximate cooling needed for the module, refer to the Power Derating Curves in Figures 2-17 .

These derating curve are approximations of the ambient temperature and airflow required to keep the power module temperature below it's maximum rating. Once the module is assembled in the actual system, the module's temperature should be verified.

TYPICAL DERATING CURVES SIP/SMT VERSION

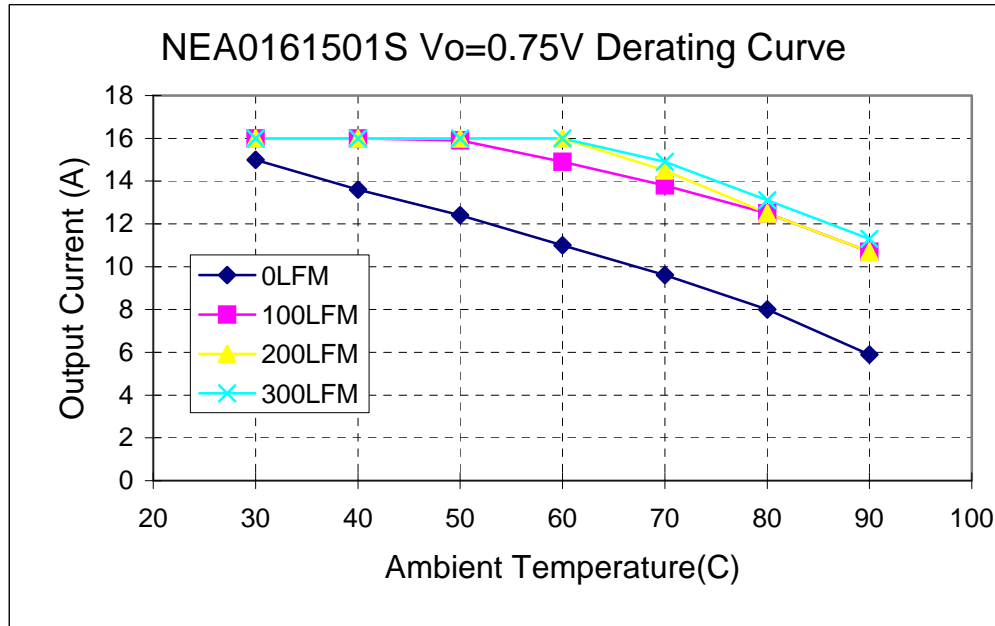

Fig. 2. SMT Power Derating vs Output Current for 12Vin 0.75V Out.

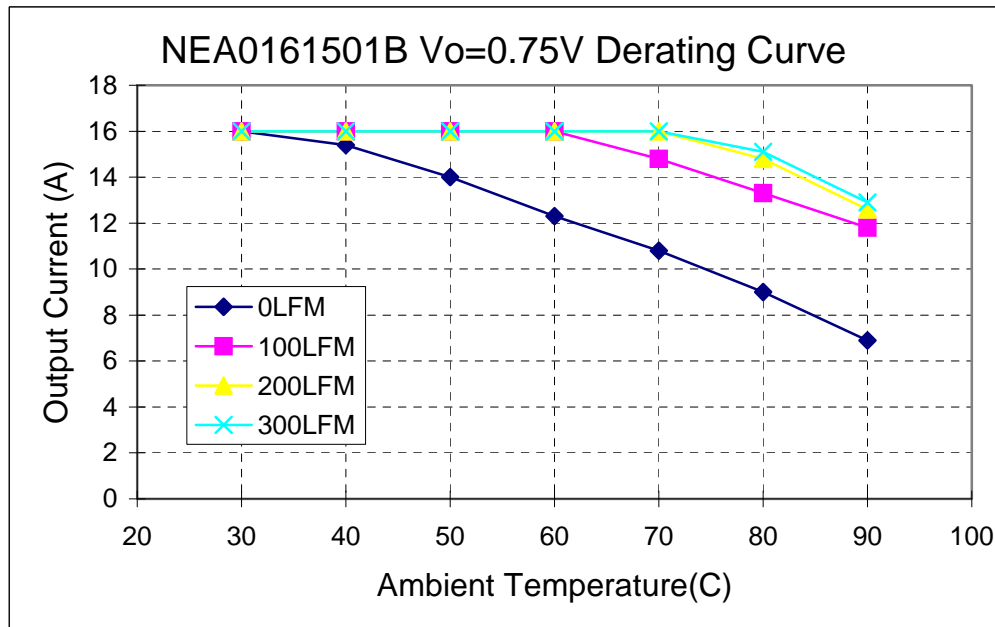

Fig. 3. SIP Power Derating vs Output Current for 12Vin 0.75V Out.

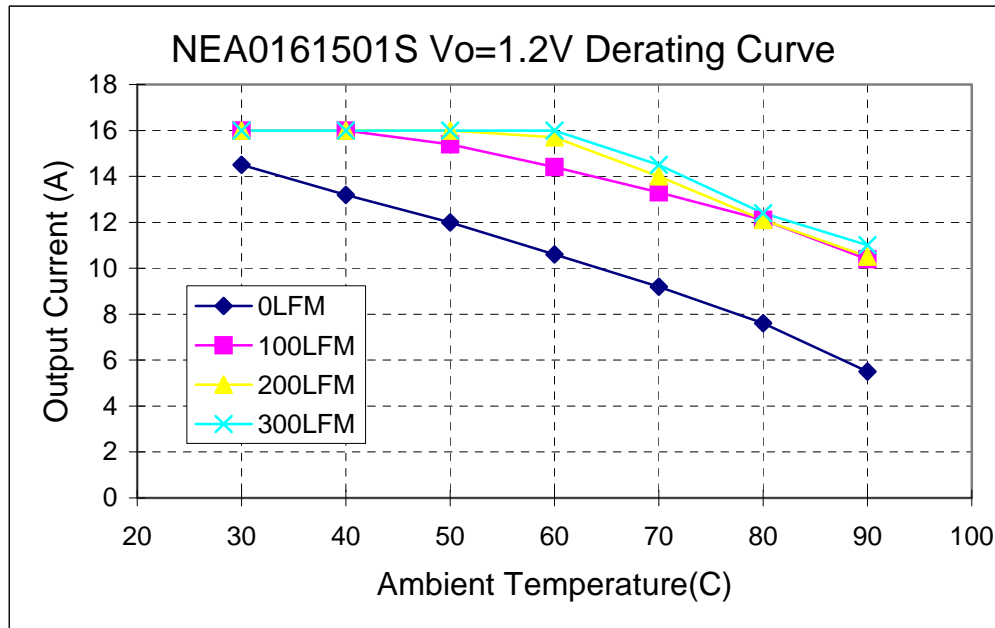

Fig 4. SMT Power Derating vs Output Current for 12Vin 1.2V Out.

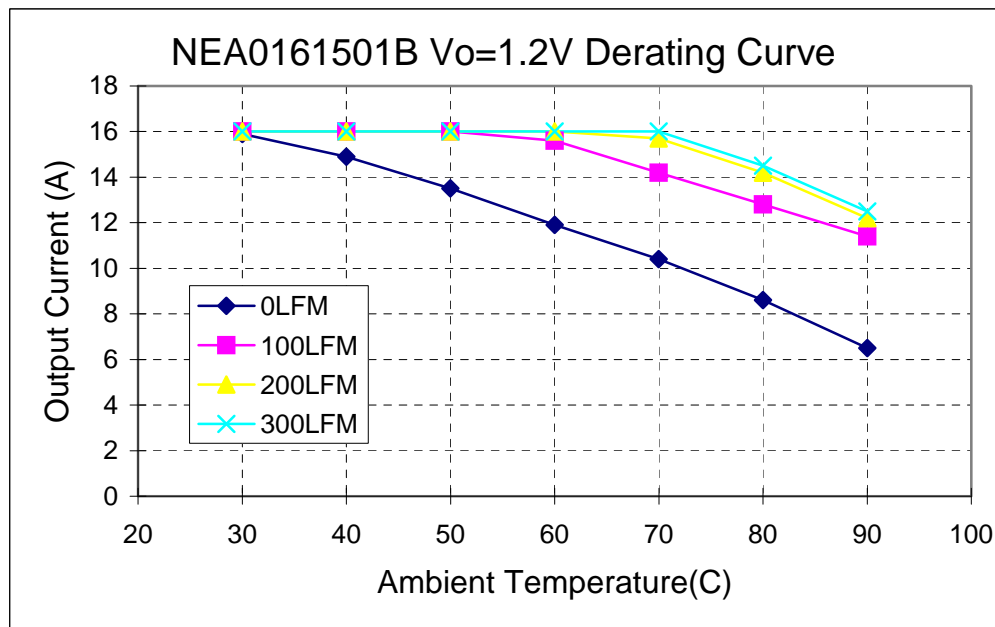

Fig 5. SIP Power Derating vs Output Current for 12Vin 1.2V Out.

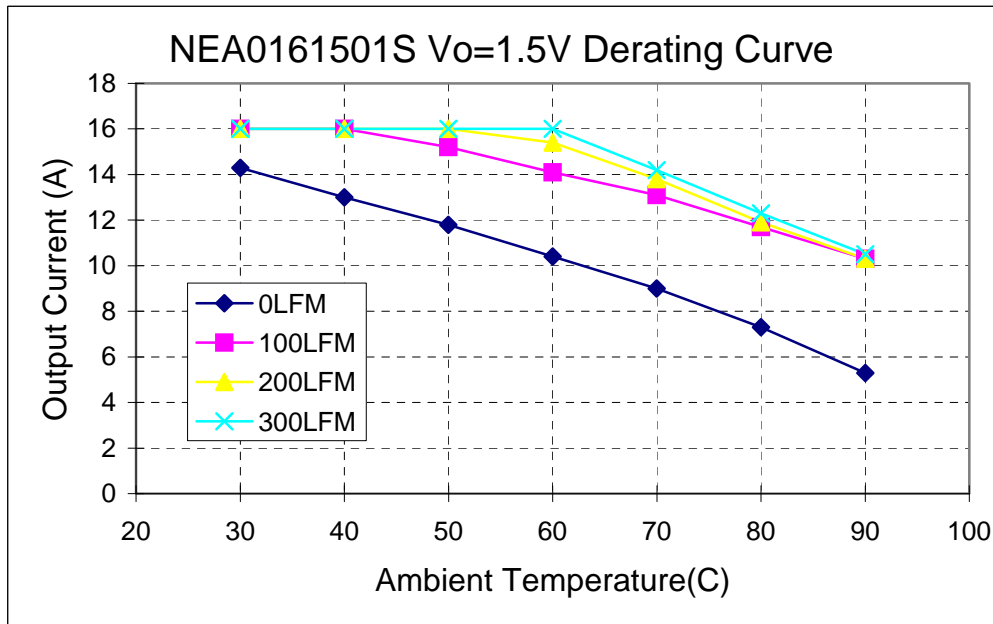

Fig 6. SMT Power Derating vs Output Current for 12Vin 1.5V Out.

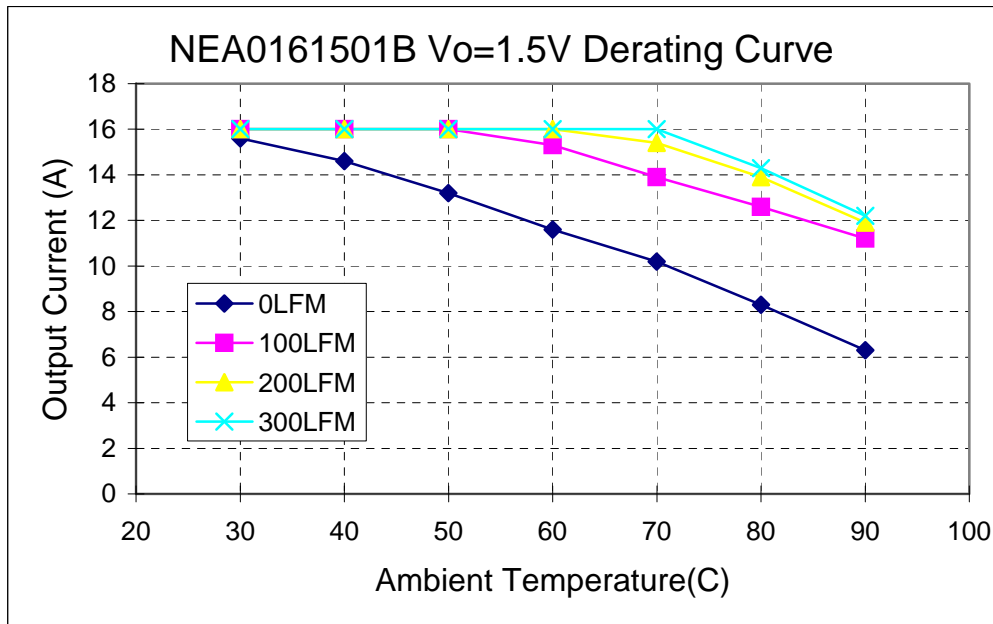

Fig 7. SIP Power Derating vs Output Current for 12Vin 1.5V Out.

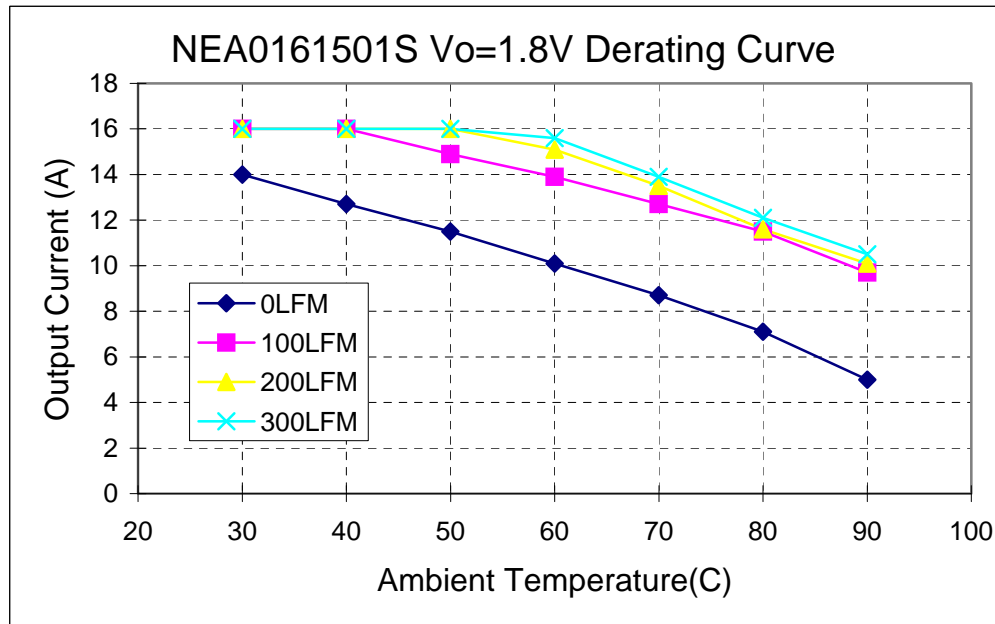

Fig 8. SMT Power Derating vs Output Current for 12Vin 1.8V Out.

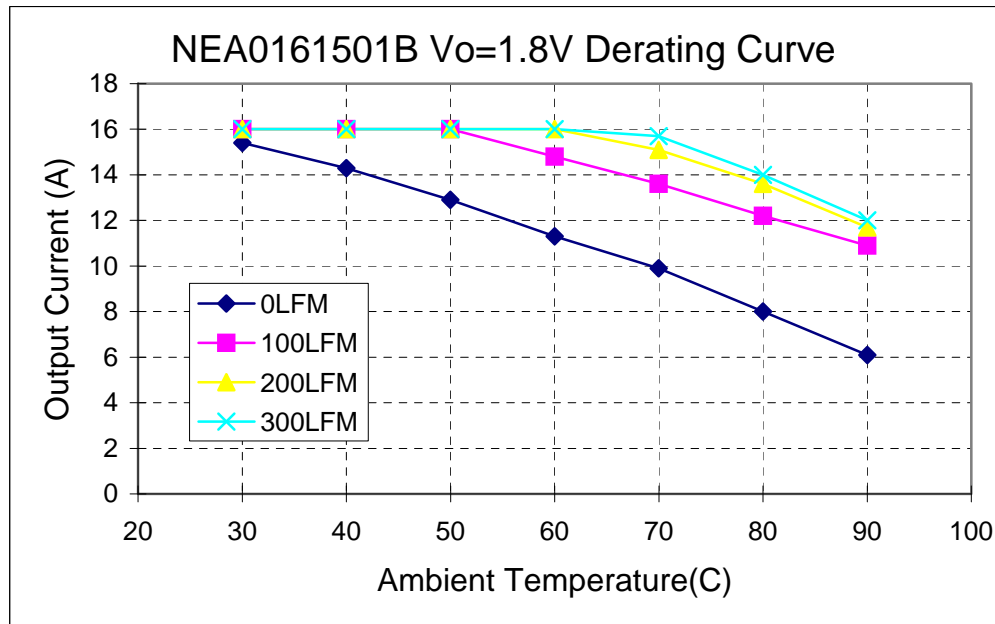

Fig 9. SIP Power Derating vs Output Current for 12Vin 1.8V Out.

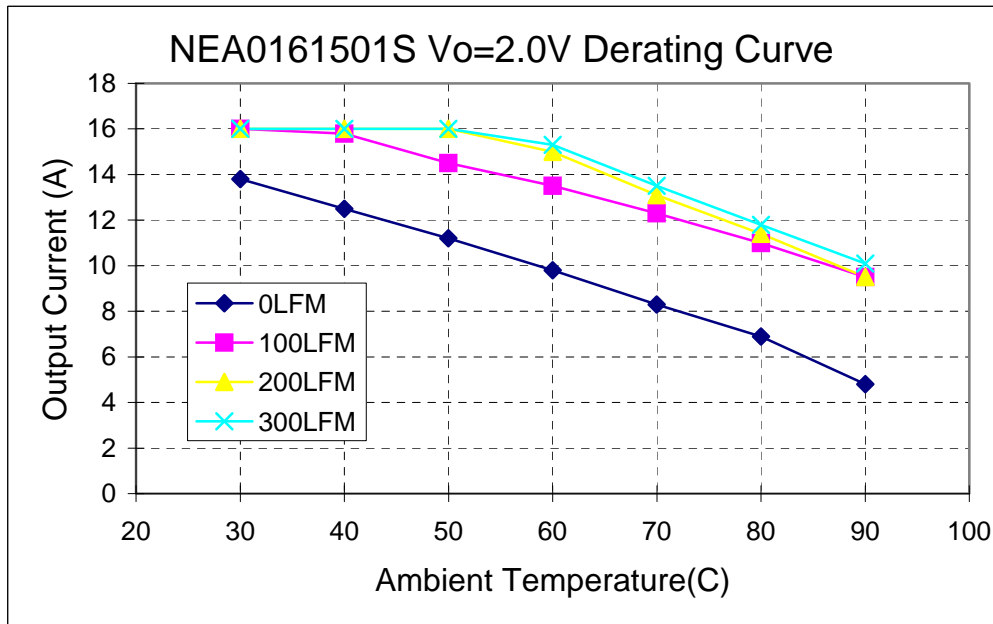

Fig 10. SMT Power Derating vs Output Current for 12Vin 2.0V Out.

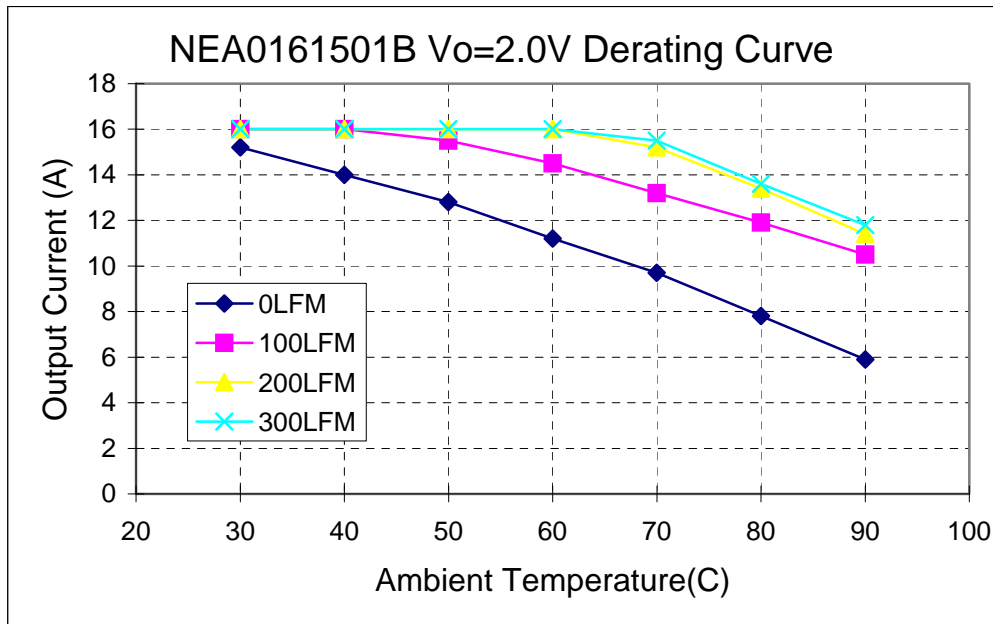

Fig 11. SIP Power Derating vs Output Current for 12Vin 2.0V Out.



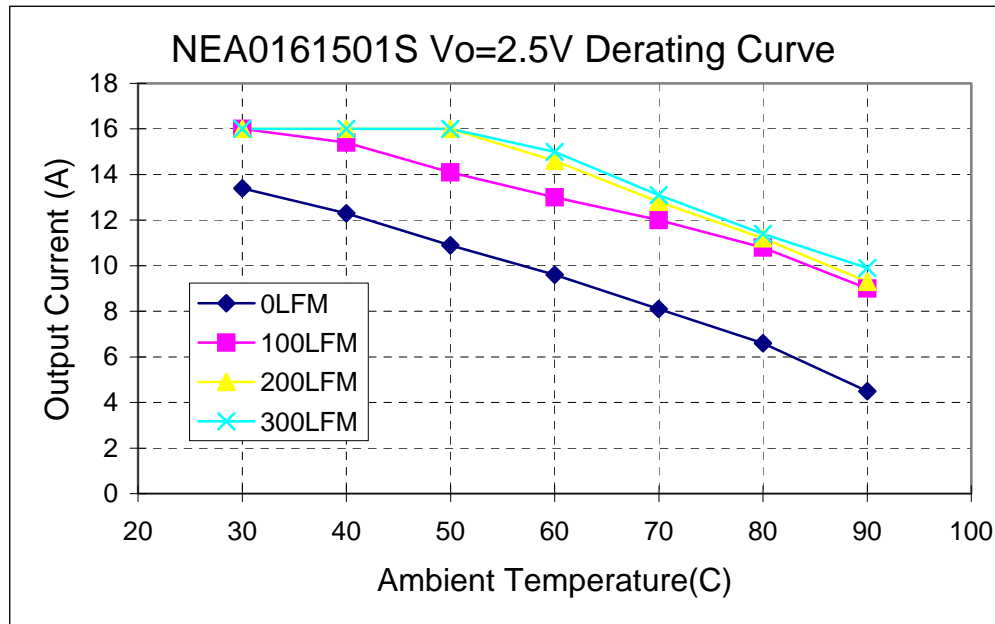

Fig 12. SMT Power Derating vs Output Current for 12Vin 2.5V Out.

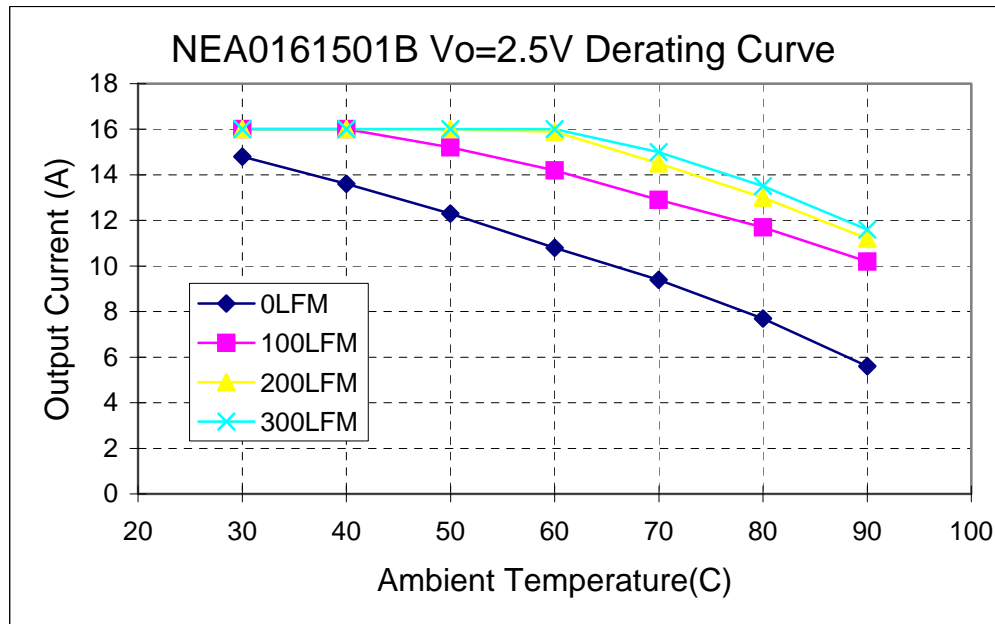

Fig 13. SIP Power Derating vs Output Current for 12Vin 2.5V Out.

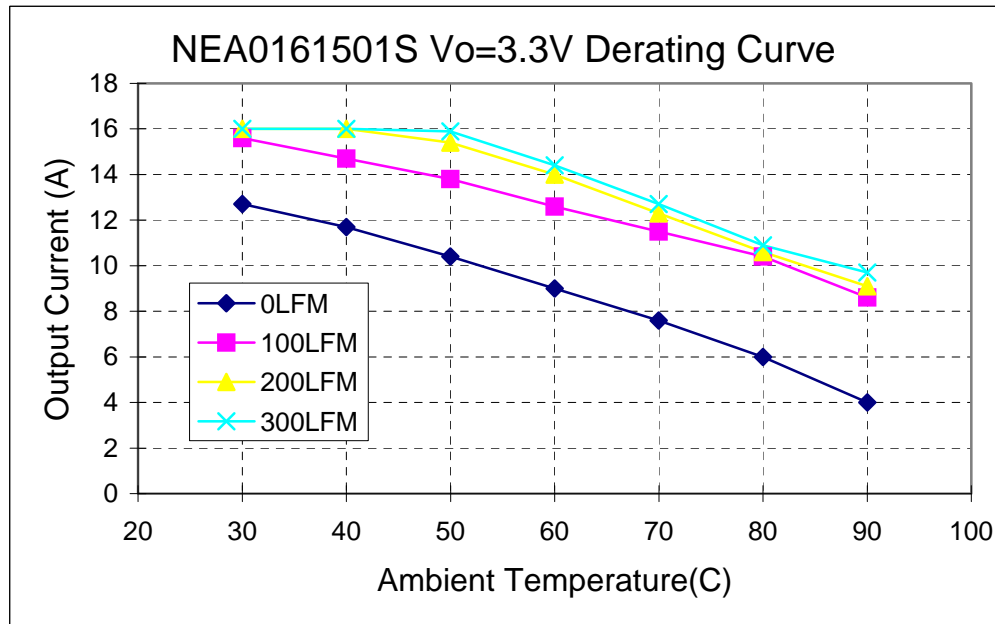

Fig. 14. SMT Power Derating vs Output Current for 12Vin 3.3V Out.

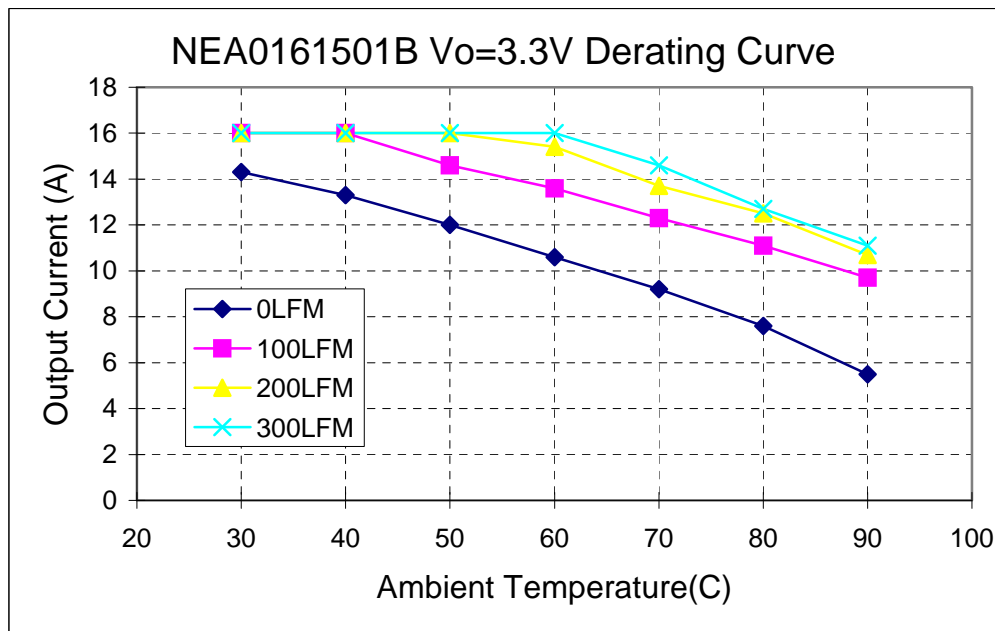

Fig. 15. SIP Power Derating vs Output Current for 12Vin 3.3V Out.

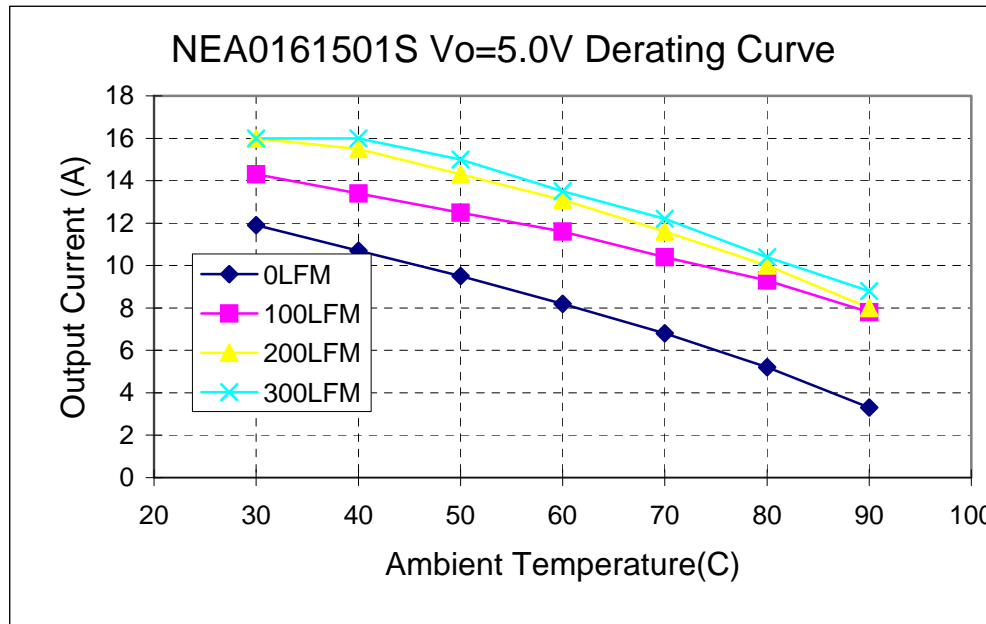

Fig. 16. SMT Power Derating vs Output Current for 12Vin 5.0V Out

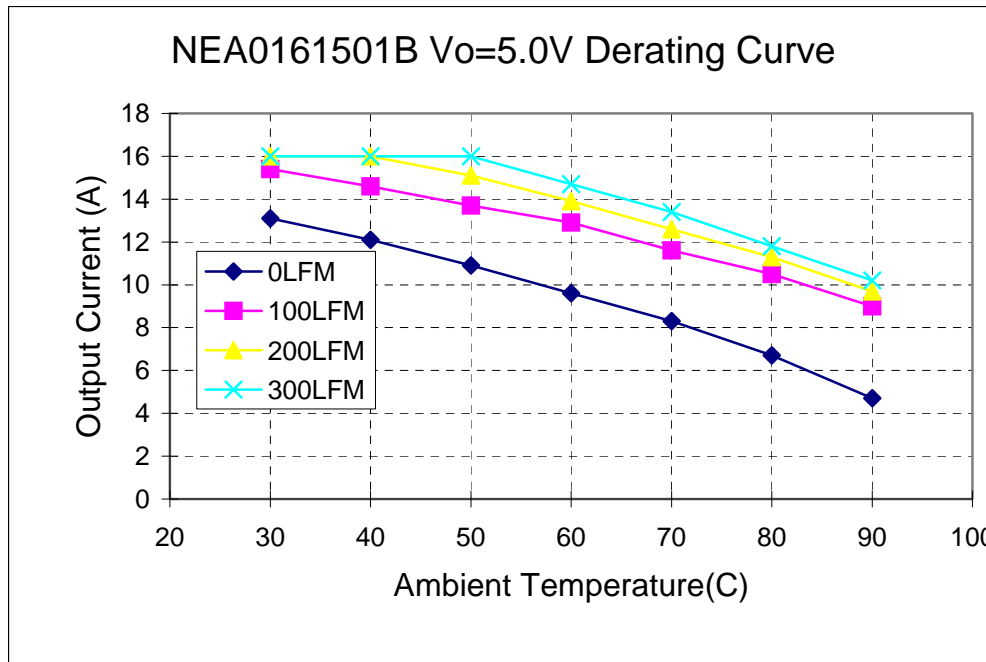

Fig 17. SIP Power Derating vs Output Current for 12Vin 5.0V Out.

**TYPICAL EFFICIENCY CURVES FOR VARIOUS VOLTAGE MODELS SIP/SMT VERSION.**

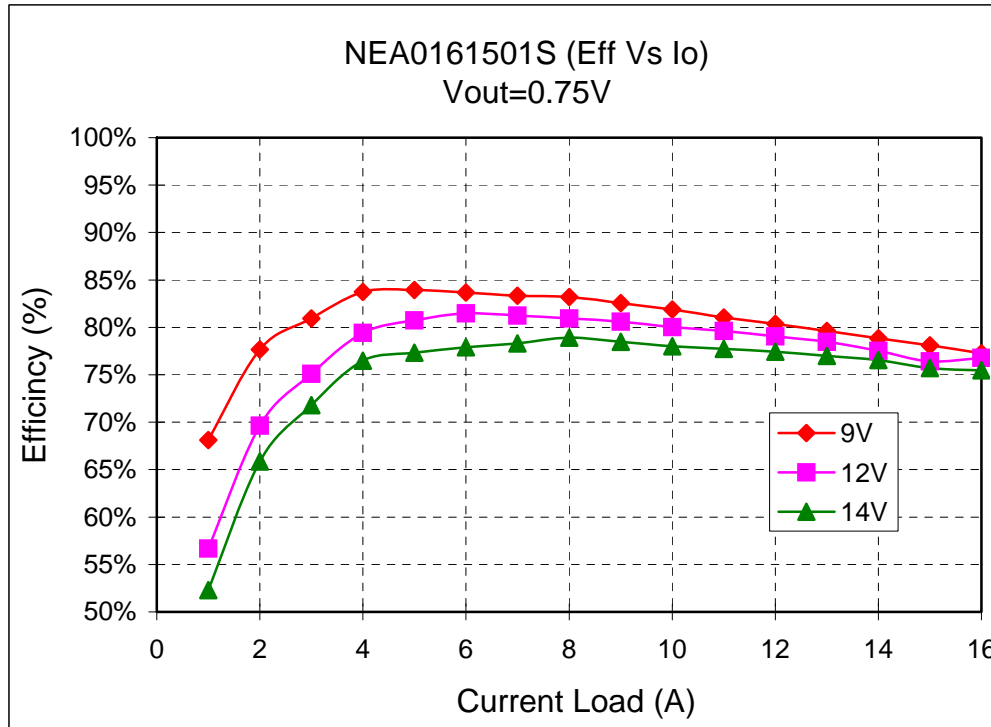

Fig 18. SMT Efficiency Curves for Vout=0.75V (25C)

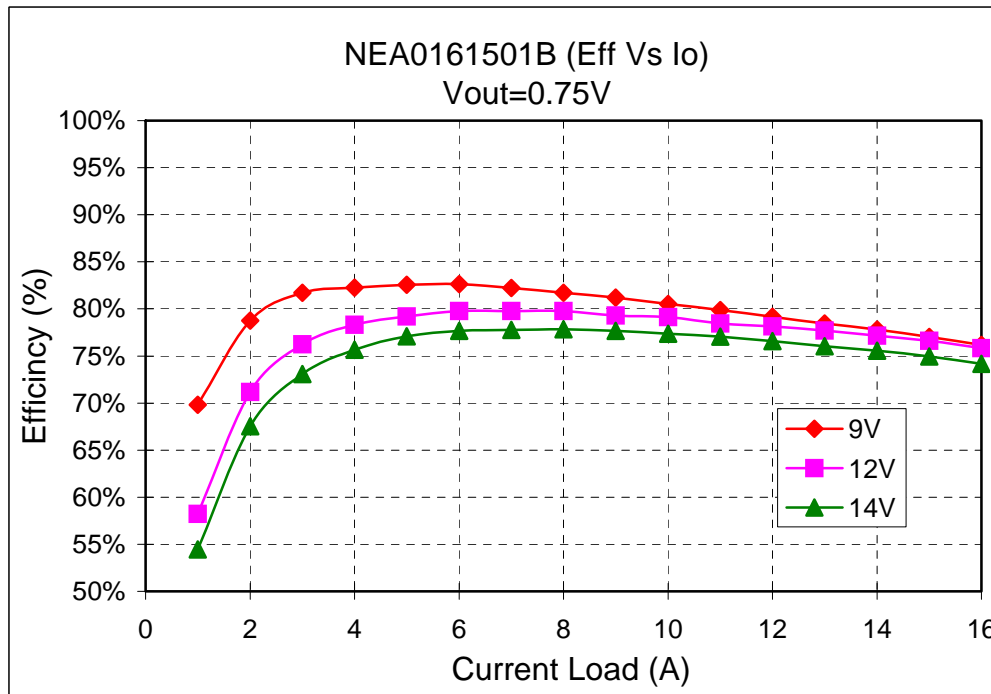

Fig 19. SIP Efficiency Curves for Vout=0.75V (25C)

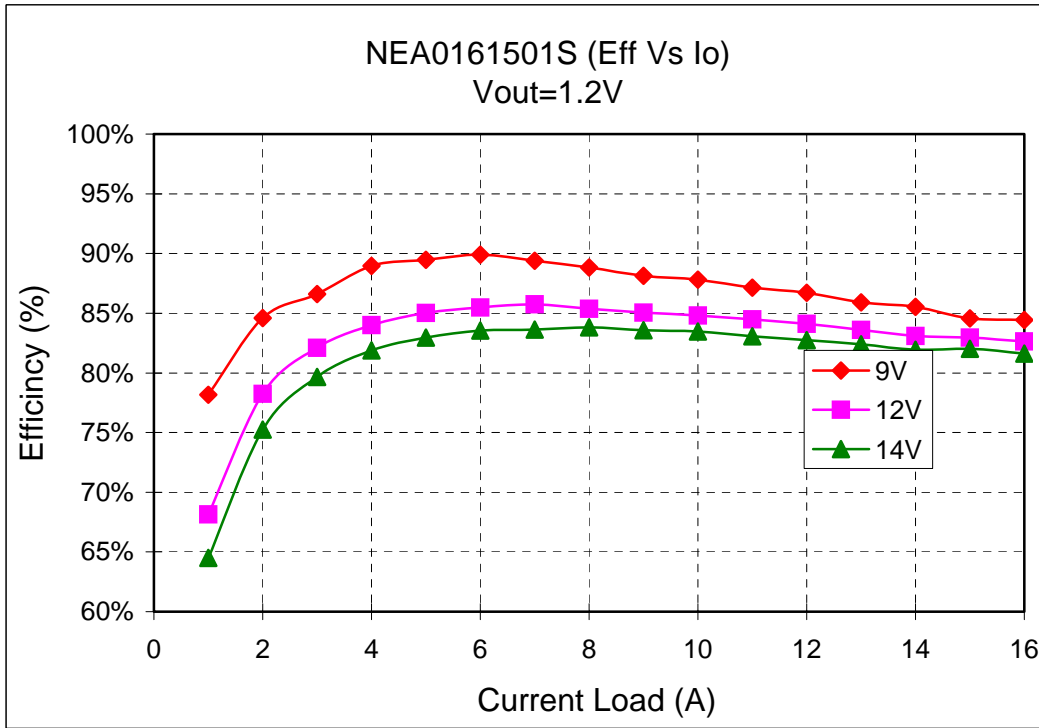

Fig 20. SMT Efficiency Curves for Vout=1.2V (25C)

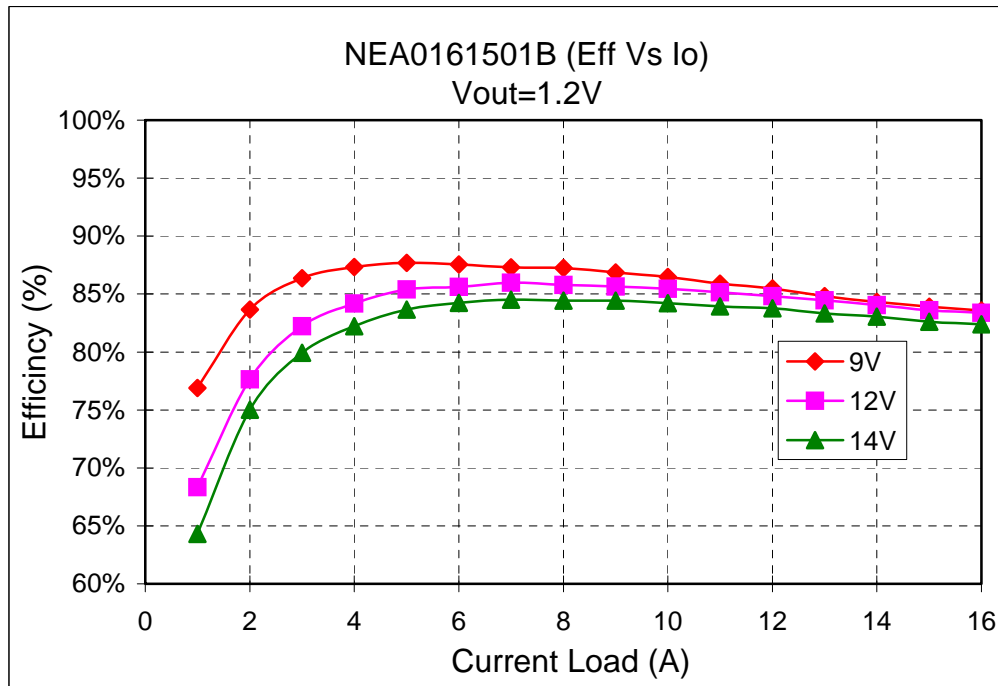

Fig 21. SIP Efficiency Curves for Vout=1.2V (25C)

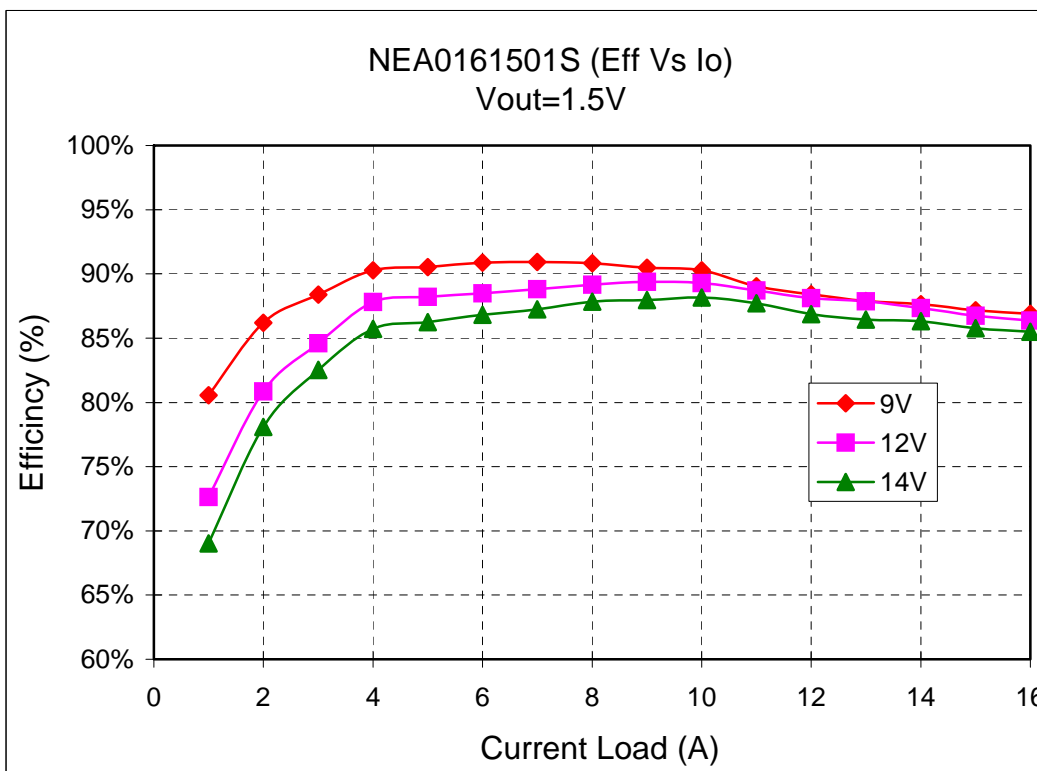

Fig 22. SMT Efficiency Curves for Vout=1.5V (25C)

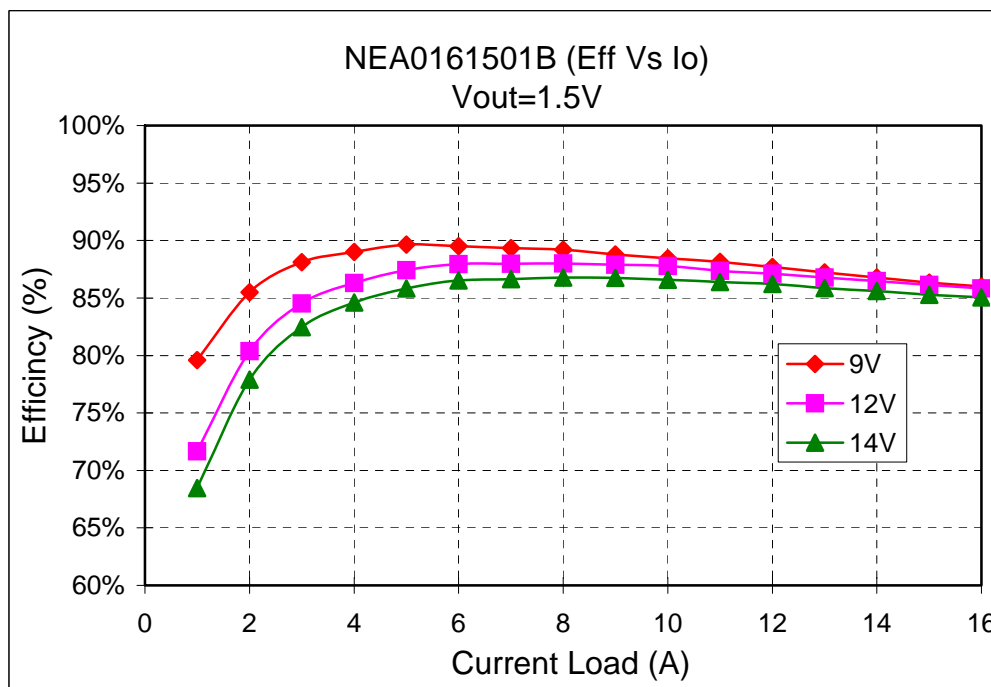

Fig 23. SIP Efficiency Curves for Vout=1.5V (25C)

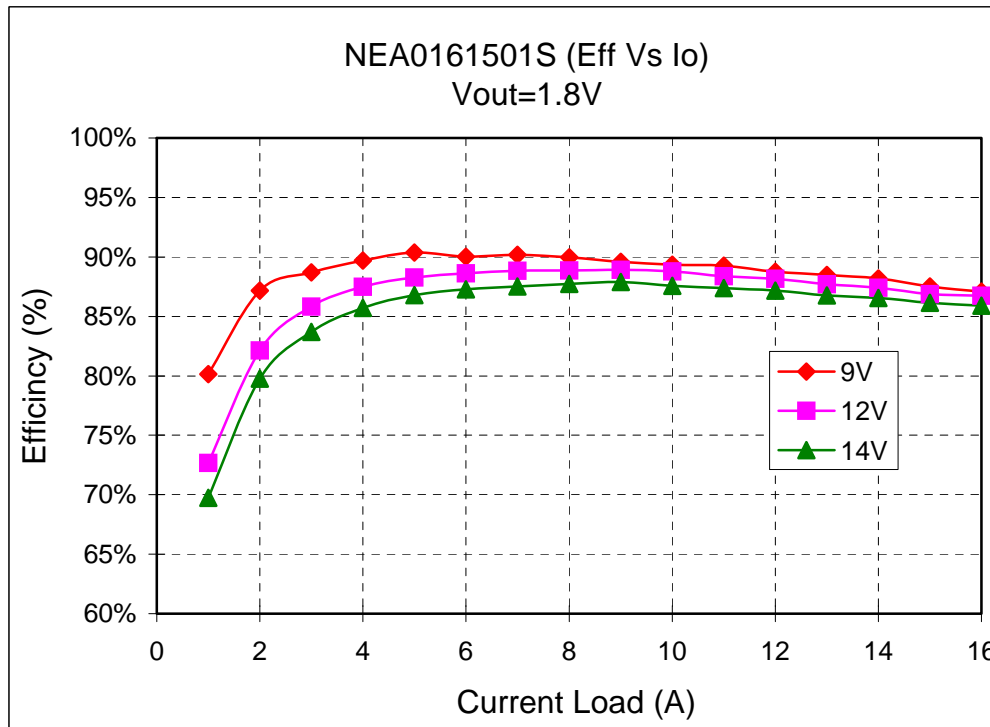

Fig 24. SMT Efficiency Curves for Vout=1.8V (25C)

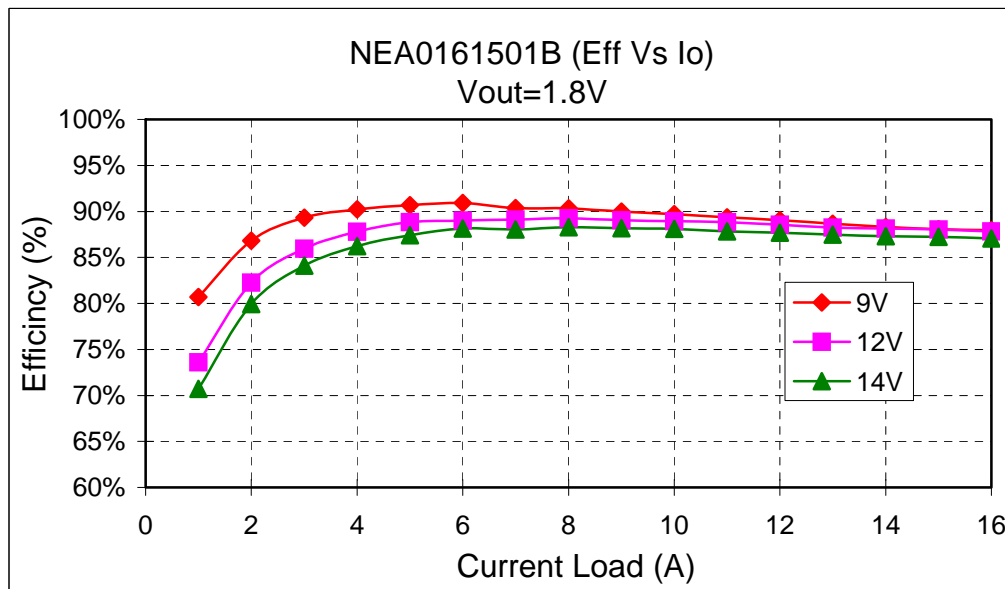

Fig 25. SIP Efficiency Curves for Vout=1.8V (25C)

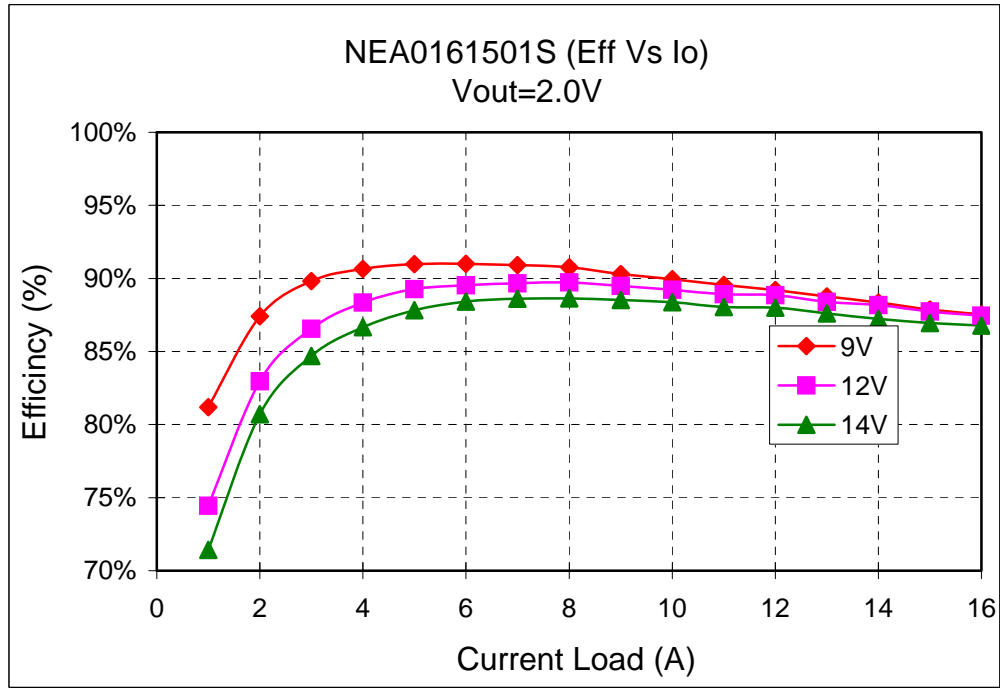

Fig 26. SMT Efficiency Curves for Vout=2.0V (25C)

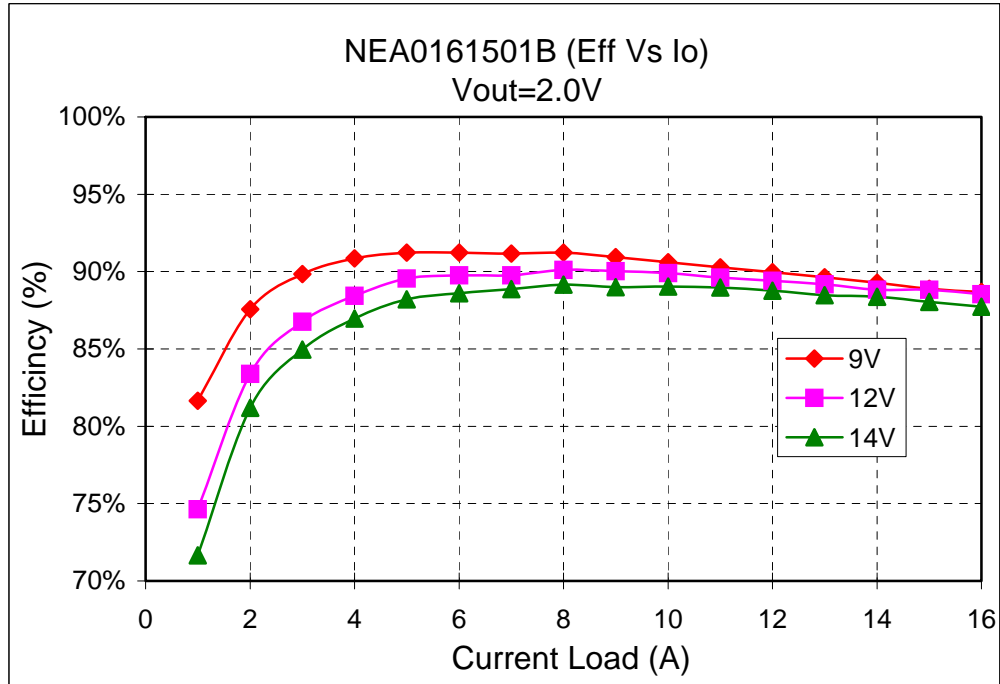

Fig 27. SIP Efficiency Curves for Vout=2.0V (25C)



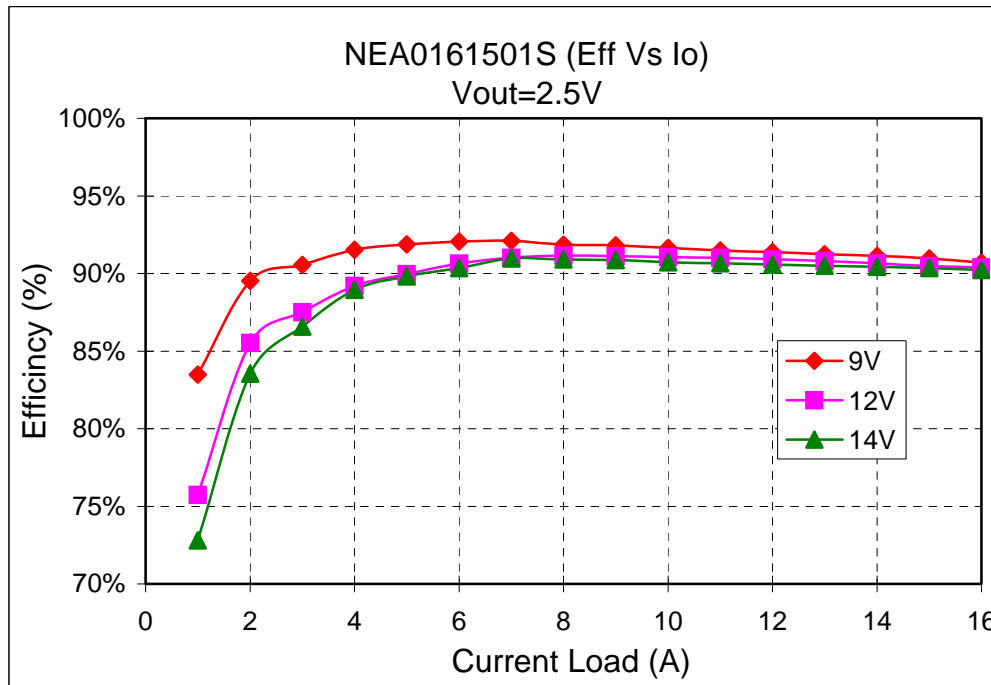

Fig 28. SMT Efficiency Curves for Vout=2.5V (25C)

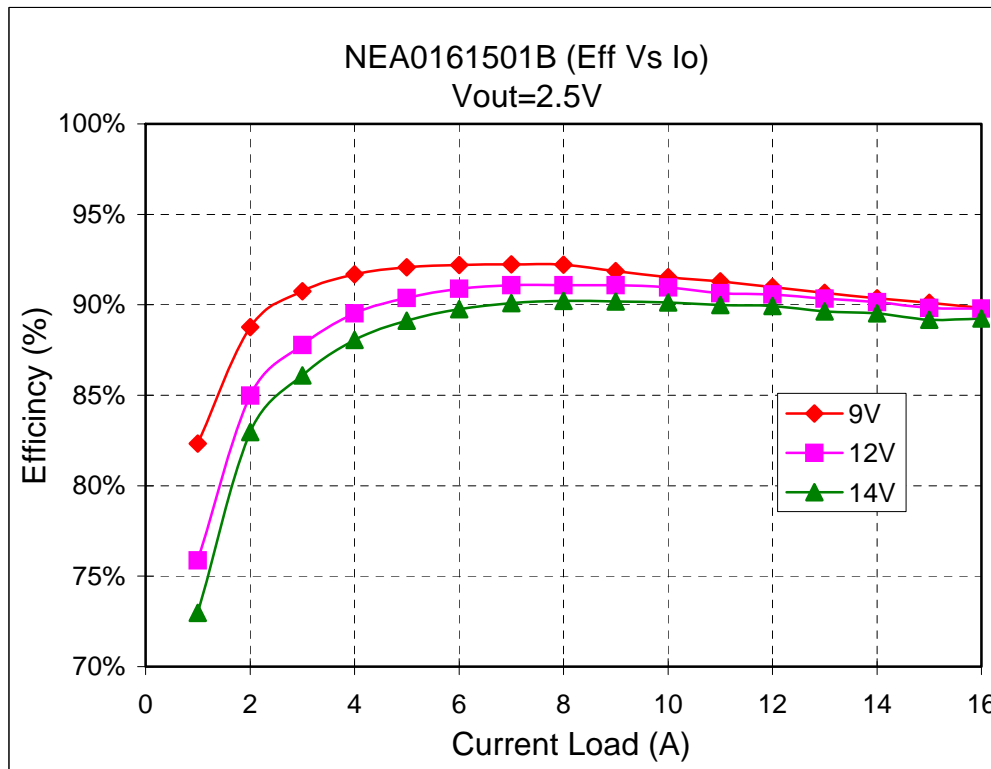

Fig 29. SIP Efficiency Curves for Vout=2.5V (25C)

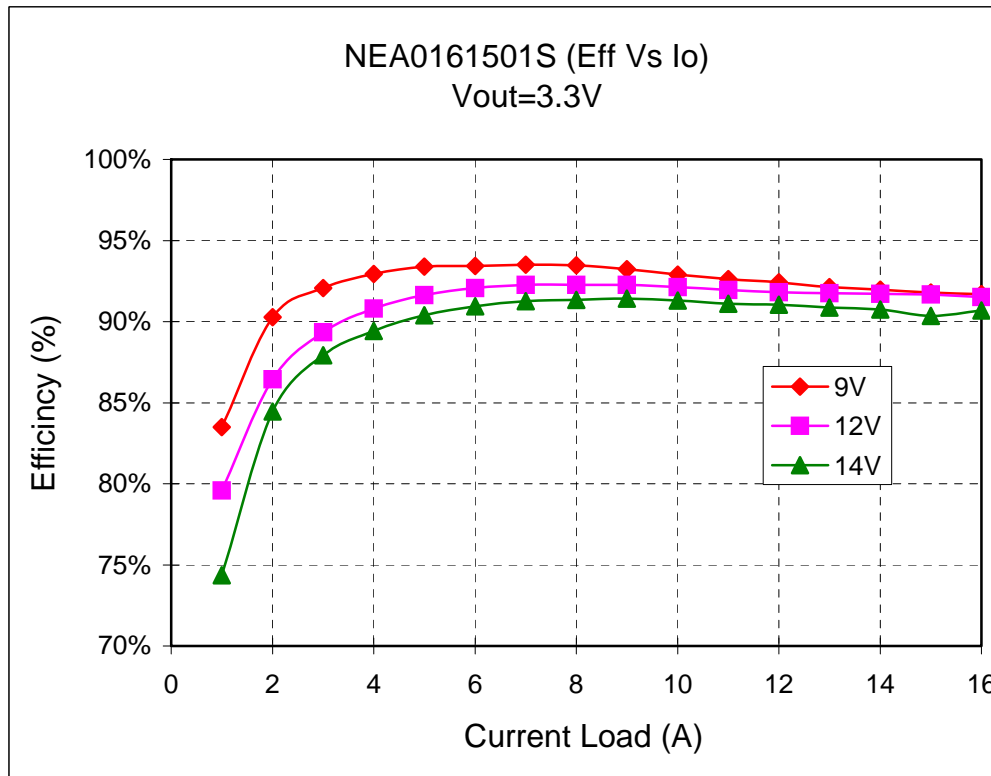

Fig 30. SMT Efficiency Curves for Vout=3.3V (25C)

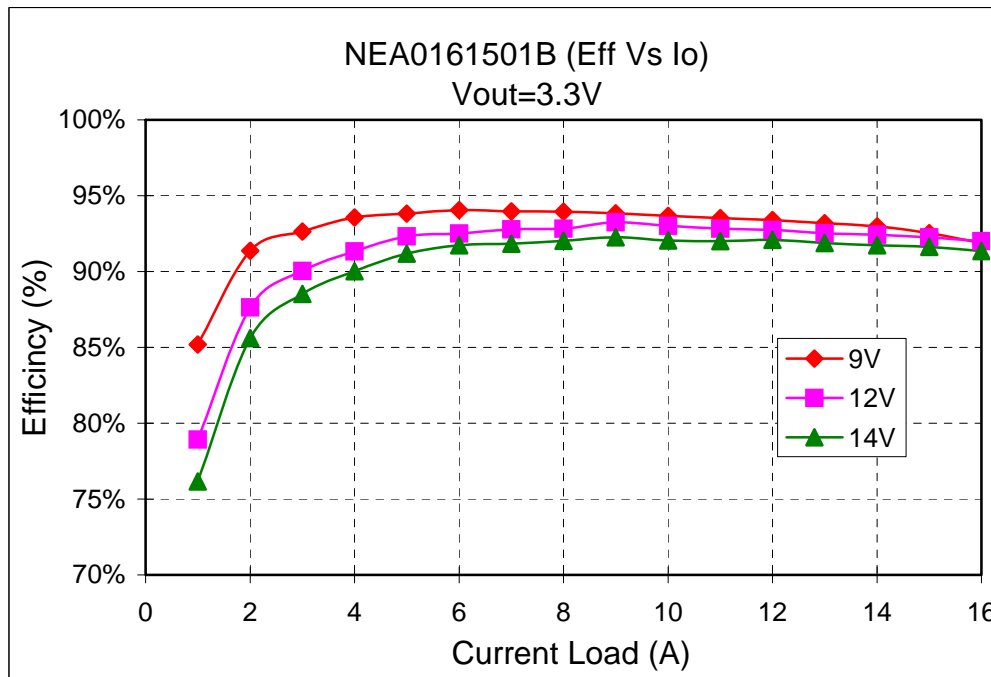

Fig 31. SIP Efficiency Curves for Vout=3.3V (25C)

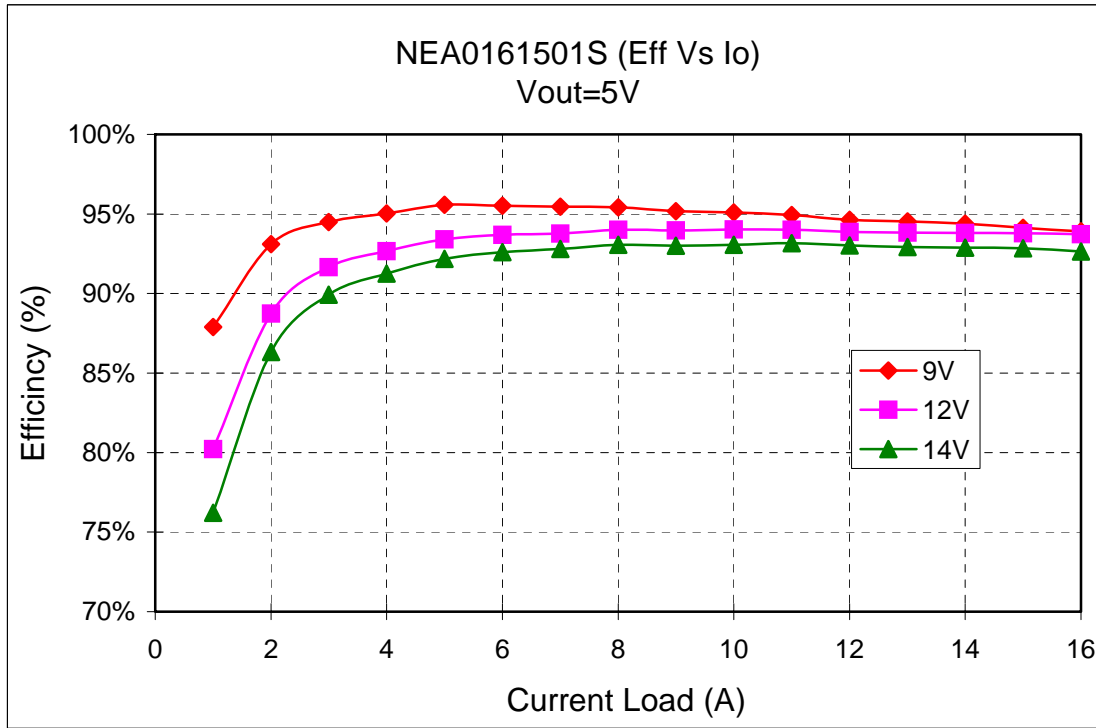

Fig 32. SMT Efficiency Curves for Vout=5.0V (25C)

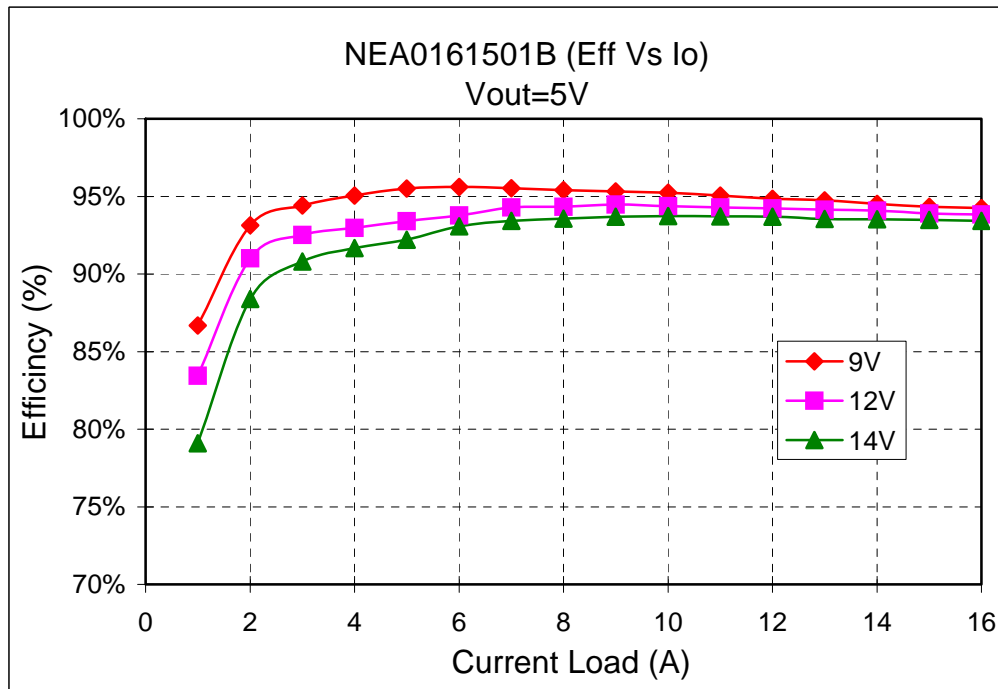
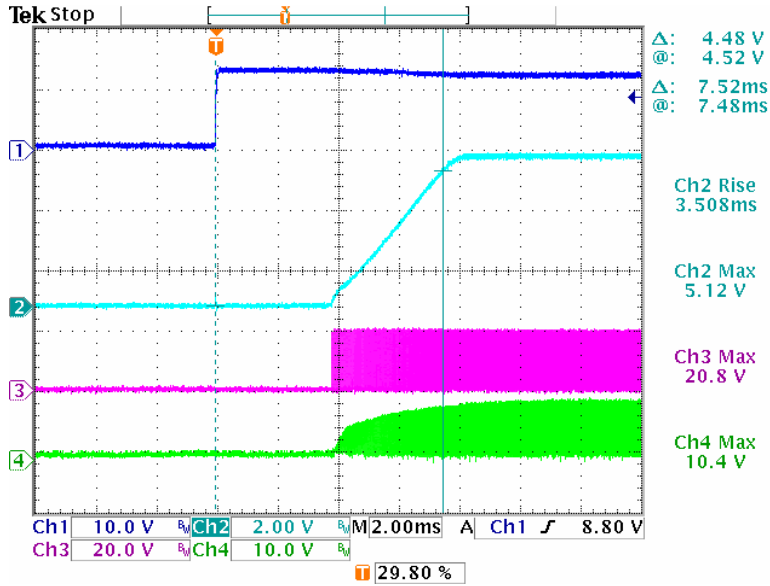

Fig 33. SIP Efficiency Curves for Vout=5.0V (25C)

### Typical Start Up

Ch1. Vin  
 Ch2. Vout, Full load.  
 Ch3. Q1-Vgs  
 Ch4. Q2-Vgs



### Typical Start Up with pre-bias

Ch1 : Enable  
 Ch2 : Vout  
 Ch3 : Output current at Full Load.

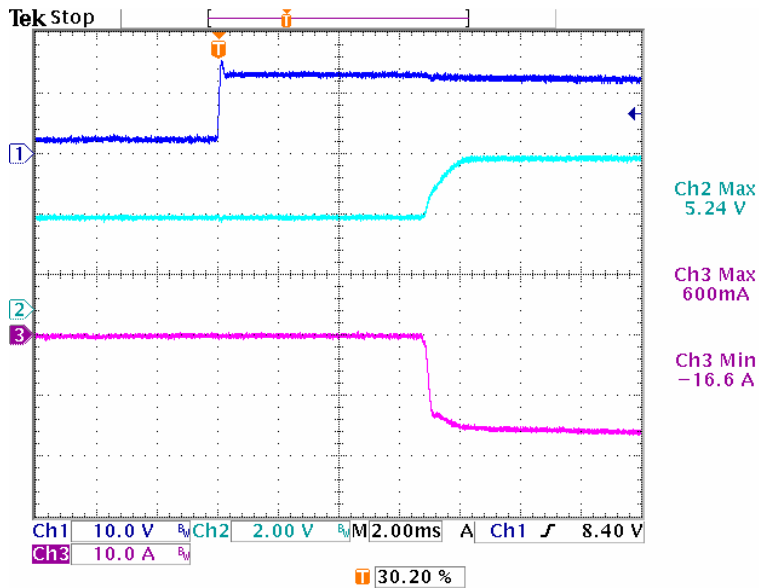

**Typical Output Noise and Ripple**

Vin = 12Vdc , Vo=5.0V/16A

Output with 1uF ceramic and 10uF tantalum capacitor

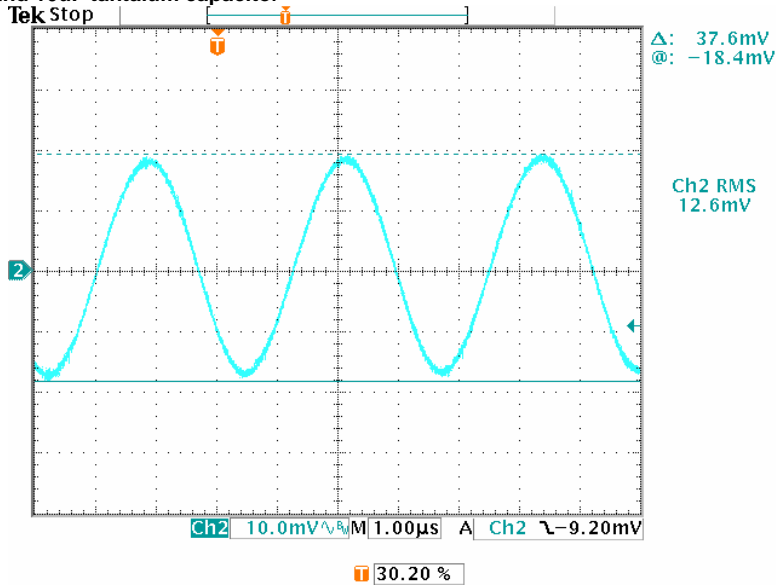

**Typical Output Transient Response**

Vin = 12Vdc , Vo=5.0V , 50% - 100% - 50% Load change , @0.1A/µs

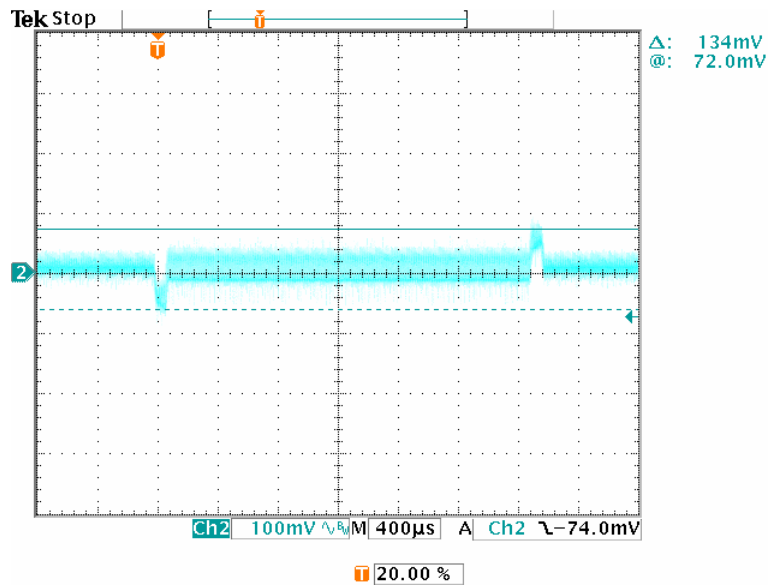

**Output Voltage Set point adjustment.**

The following relationship establish the calculation of external resistors:

$$R_{adj} = \left( \frac{15 \times 0.7}{V_o - 0.7525} \right) - 1 \text{ (K}\Omega\text{)}$$

For Vout setting an external resistor is connected between the TRIM and Ground Pin.

Resistor values for different output voltages are calculated as given in the table:

Vo, set (Volts)	RAdj (KΩ)
0.75	Open
1.2	22.46
1.5	13.05
1.8	9.024
2.0	7.417
2.5	5.009
3.3	3.122
5.0	1.472

**Remote Sense:**

All MURATA POWER SOLUTIONS SMT/SIP power modules offer an option for remote sense. The remote sense compensates for any distribution drops to accurately control voltage at the point of load. The voltage between the sense pin to Vout pin should not exceed 0.5V.

**SMT Lead free Reflow profile**

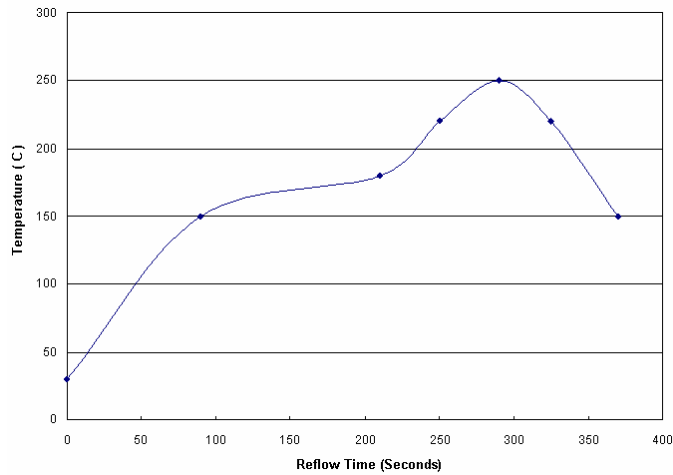

1. Ramp up rate during preheat : 1.33 °C/Sec ( From 30°C to 150°C )
2. Soaking temperature : 0.29 °C/Sec ( From 150°C to 180°C )
3. Ramp up rate during reflow : 0.8 °C/Sec ( From 220°C to 250°C )
4. Peak temperature : 250°C, above 220°C 40 to 70 Seconds
5. Ramp up rate during cooling : -1.56 °C/Sec ( From 220°C to 150°C )

**Mechanical and pinning Information.**

Given below is the outline drawing showing physical dimensions of the SIP & SMT package.

The external dimensions for SMT package are 33.00mm X 13.46mm X 9.3mm.

**BOTTOM VIEW OF BOARD**

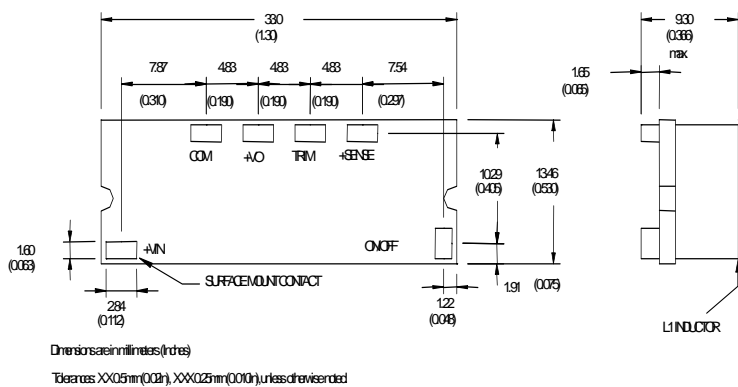

**Recommended Pad Layout**

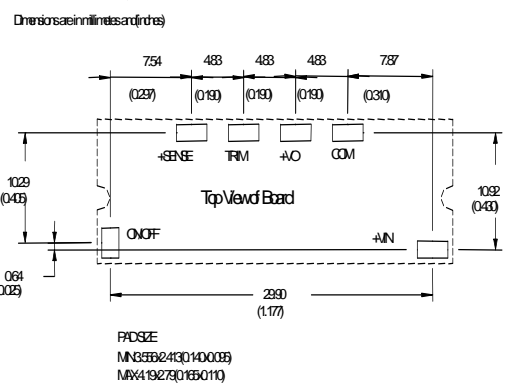

Whereas, the external dimensions of the SIP version are 50.8mm X 12.70mm X 8.30mm.

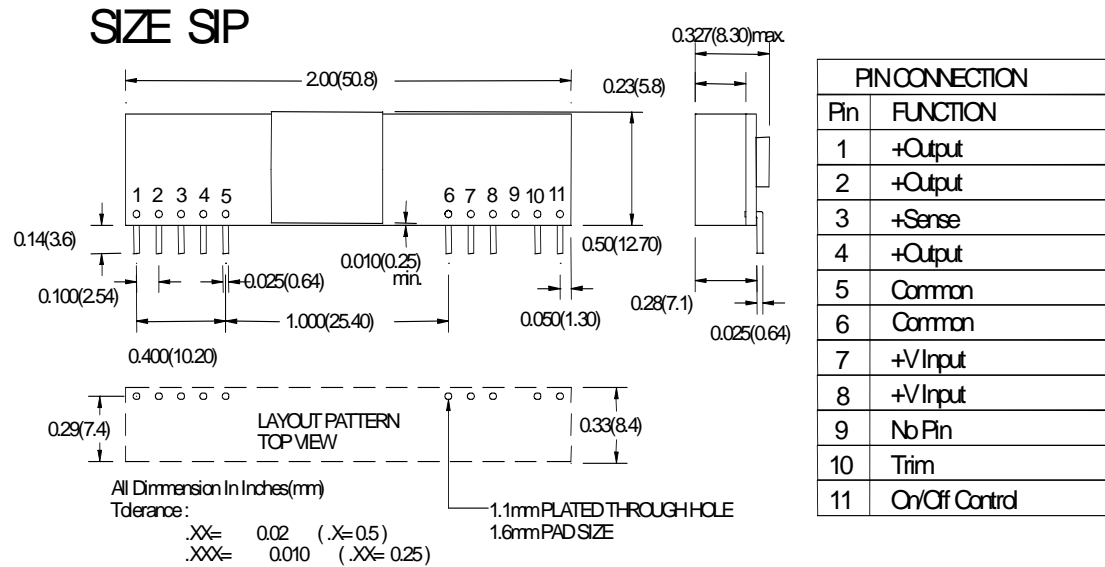

### Safety Considerations

The NEA series of converters are certified to IEC/EN/CSA/UL 60950. If this product is built into information technology equipment, the installation must comply with the above standard. An external input fuse (no more 20 A recommended) must be used to meet the above requirements. The output of the converter [Vo(+)/Vo(-)] is considered to remain within SELV limits when the input to the converter meets SELV or TNV-2 requirements. The converters and materials meet UL 94V-0 flammability ratings.

### Ordering Information

Part Number	Vin	Vout	Iout	Enable Logic	Pin Length
NEA0161500B0C	8.3V - 14.0V	0.75V - 5.0V	16A	Negative	0.139"
NEA0161500S0C	8.3V - 14.0V	0.75V - 5.0V	16A	Negative	SMT
NEA0161501B0C	8.3V - 14.0V	0.75V - 5.0V	16A	Positive	0.139"
NEA0161501S0C	8.3V - 14.0V	0.75V - 5.0V	16A	Positive	SMT





**Label Information**

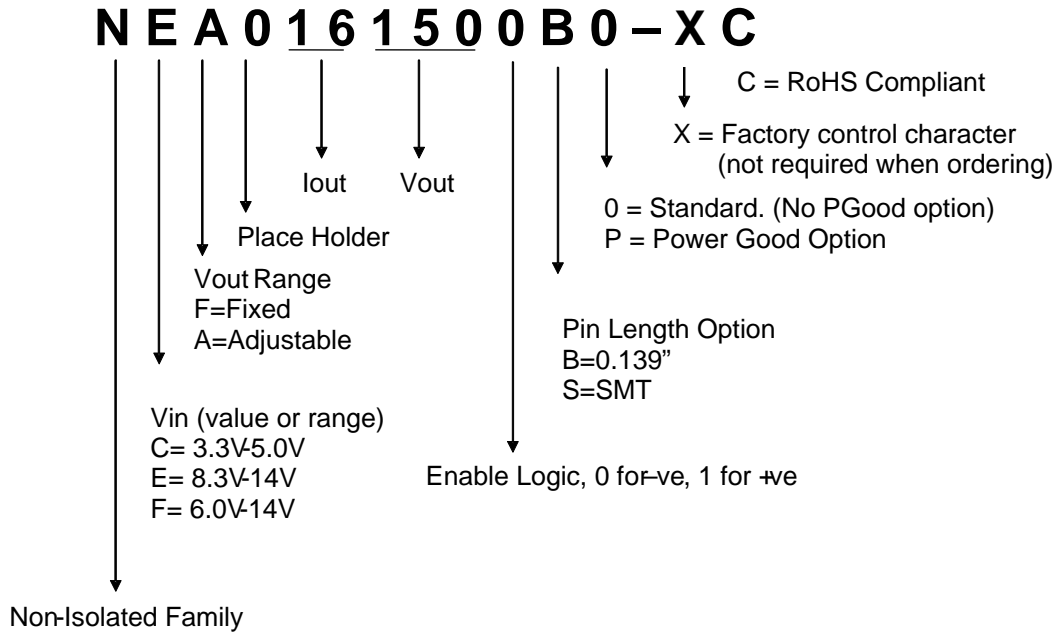

**RoHS Compliant**

The NEA016 series of converters is in compliance with the European Union Directive 2002/95/EC (RoHS) with respect to the following substances: lead (Pb), mercury (Hg), cadmium (Cd), hexavalent chromium, polybrominated biphenyls (PBB) or polybrominated diphenyl ethers (PBDE).